

INSTRUCTIONS FOR USE

Hydroven 3



Contents

1. Safety	3
1.1 Warnings	3
2. Electromagnetic Compatibility	5
3. Introduction	8
3.1 About this Manual	8
3.2 Intended Use	8
3.3 About the Hydroven 3 system	8
3.4 Use Environment	8
4. Clinical Applications	9
4.1 Indications	9
4.2 Contraindications	10
5. Preliminary Checks	11
6. Clinical Treatment Guide	12
7. Garment and Insert Information	13
7.1 Garment Description	13
7.2 Selecting the correct Garment	13
7.3 Applying the Garment	14
8. Operation	16
8.1 Pump Description	16
8.2 Operation	17
8.2.1 To Adjust the Pressure Control Knob Position	17
8.2.2 Switch On	17
8.2.3 To Set the Garment Pressure	18
8.2.4 Shut Down	18
8.2.5 To Remove the Garment	18
9. Decontamination	19
9.1 Cleaning	19
9.2 Chemical Disinfection	19
9.3 Cleaning and Sterilising Garments	20

10. Routine Maintenance	21
10.1 Hydroven 3 System.....	21
10.1.1 Maintenance	21
10.1.2 Servicing	21
10.1.3 Service Period.....	21
10.2 Hydroven 3 Pump	21
10.2.1 General Care, Maintenance and Inspection.....	21
10.2.2 Serial Labels	21
11. Trouble Shooting	22
12. Accessories	23
13. Specifications	25
13.1 Equipment Classification	25
13.2 General	25
13.3 Environmental	26
13.4 Standards Compliance	26
14. Product Labelling	27
15. End of Life Disposal	28
16. Warranty & Service.....	29
16.1 Service Returns.....	29

1. Safety



Before using this equipment, please study this manual carefully and familiarise yourself with the controls, display features and operation. Ensure that each user fully understands the safety and operation of the unit, as mis-use may cause harm to the user or patient, or damage to the product.

Please keep these Instructions for Use to hand for future reference.

Symbols



General Warning/Cautions



Follow Instructions for Use

1.1 Warnings

Do NOT use unapproved accessories or attempt to modify, disassemble or otherwise misuse the Hydroven 3 system. Failure to observe this caution could result in injury, or in extreme cases, death.



WARNING: A possible explosion hazard exists if used in the presence of flammable anaesthetics.



WARNING: Do not mount the unit directly above the patient. Locate the unit so that it will not cause harm should it fall.



WARNING: Do not operate the unit from the mains supply if the mains cable is damaged.



WARNING: Do not immerse any portion of the unit in water or other liquids.



WARNING: Use only recommended accessories listed in this manual.



WARNING: If this product is connected to another item of electrical equipment, it is important that the system is fully compliant with EN60601-1.



WARNING: It is the responsibility of the care giver to ensure that the user can use this product safely.



WARNING: Make sure that the mains power cable and tubeset or air hoses are positioned to avoid causing a trip or other hazard, and are clear of moving bed mechanisms or other possible entrapment areas.



WARNING: Electrical equipment may be hazardous if misused. There are no user-serviceable parts inside the pump. The pump's case must only be removed by authorised technical personnel. No modification of this equipment is allowed.



WARNING: The mains power socket/plug must be accessible at all times. To disconnect the pump completely from the electricity supply, remove the plug from the mains power socket.



WARNING: Disconnect the pump from the mains power socket before cleaning and inspecting.



WARNING: Only the pump and garment/insert combination as indicated by Huntleigh should be used. The correct function of the product cannot be guaranteed if incorrect pump and garment combinations are used.



WARNING: Bags supplied with this equipment may present a suffocation risk; to avoid the risk of suffocation, keep the bags away from babies and small children.



CAUTION: Do not expose the system to naked flames, such as cigarettes, etc.



CAUTION: Do not store the system in direct sunlight.



CAUTION: Do not use phenol-based solutions to clean the system.



CAUTION: Make sure the system is clean and dry prior to use or storage.



CAUTION: Pets and children must be supervised in the vicinity of the system.



Caution (applicable to the USA market only)
US Federal law restricts this device to sale by or on the order of a physician.

Service Life

This has been defined as the minimum time period during which the device is expected to remain safe and suitable to meet its intended use, and all risk control measures remain effective.

Huntleigh Healthcare Ltd's commitment is that the expected service life for this Device has been defined as 7 years.

2. Electromagnetic Compatibility

Make sure the environment in which Hydroven 3 is installed is not subject to strong sources of electromagnetic interference (e.g. radio transmitters, mobile phones).

This equipment generates and uses radio frequency energy. If not installed and used properly, in strict accordance with the manufacturer's instructions, it may cause or be subject to interference. Type-tested in a fully configured system, complies with EN60601-1-2, the standard intended to provide reasonable protection against such interference. Whether the equipment causes interference may be determined by turning the equipment off and on. If it does cause or is affected by interference, one or more of the following measures may correct the interference:

- Reorienting the equipment
- Relocating the equipment with respect to the source of interference
- Moving the equipment away from the device with which it is interfering
- Plugging the equipment into a different outlet so that the devices are on different branch circuits



If this equipment needs to be used adjacent to other electrical equipment, normal operation must be checked before use.

Guidance and Manufacturer's declaration - electromagnetic emissions

The Hydroven 3 is intended for use in the electromagnetic environment specified below. The customer or the user of the Hydroven 3 should assure that it is used in such an environment.

Emissions Test	Compliance	Electromagnetic Environment - guidance
RF emissions CISPR 11	Group 1	The Hydroven 3 uses RF energy only for its internal function. Therefore, its RF emissions are very low and are not likely to cause any interference in nearby electronic equipment.
RF emissions CISPR 11	Class B	
Harmonic emissions IEC 61000-3-2	Class A	
Voltage fluctuations / flicker emissions IEC 61000-3-3	Complies	

Guidance and Manufacturer's declaration - electromagnetic immunity

The Hydroven 3 is intended for use in the electromagnetic environment specified below. The customer or the user of the Hydroven 3 should assure that it is used in such an environment.

Immunity Test	IEC 60601 test level	Compliance level	Electromagnetic Environment - guidance
			Portable and mobile RF communications equipment should be used no closer to any part of the Hydroven 3, including cables, than the recommended separation distance calculated from the equation applicable to the frequency of the transmitter.
Conducted RF IEC 61000-4-6	3 Vrms 150kHz to 80MHz	3V	$d = 1.2 \sqrt{P}$
Radiated RF IEC 61000-4-3	3 Vrms 80MHz to 2.5MHz	3V/m	$d = 1.2 \sqrt{P}$ 80MHz to 800MHz $d = 2.3 \sqrt{P}$ 800MHz to 2.5GHz
			<p>where P is the maximum output power rating of the transmitter in watts (W) according to the transmitter manufacturer and d is the recommended separation distance in metres (m).</p> <p>Field strengths from fixed RF transmitters, as determined by an electromagnetic site survey, ^a should be less than the compliance level in each frequency range ^b.</p> <p>Interference may occur in the vicinity of the equipment marked with the following symbol:</p> 

NOTE 1 At 80MHz and 800MHz, the higher frequency range applies.

NOTE 2 These guidelines may not apply in all situations. Electromagnetic propagation is affected by absorption and reflection from structures, objects and people.

^a Field strengths from fixed transmitters, such as base stations for radio (cellular/cordless) telephones and land mobile radios, amateur radio, AM and FM radio broadcast and TV broadcast cannot be predicted theoretically with accuracy. To assess the electromagnetic environment due to fixed RF transmitters, an electromagnetic site survey should be considered. If the measured field strength in the location in which the Hydroven 3 is used exceeds the applicable RF compliance level above, the Hydroven 3 should be observed to verify normal operation. If abnormal performance is observed, additional measures may be necessary, such as re-orienting or relocating the Hydroven 3.

^b Over the frequency range 150kHz to 80kHz, field strengths should be less than 3V/m.

Recommended separation distances between portable and mobile RF communications equipment and the Hydroven 3

The Hydroven 3 is intended for use in an electromagnetic environment in which radiated RF disturbances are controlled. The customer or user of the Hydroven 3 can help prevent electromagnetic interference by maintaining a minimum distance between portable and mobile RF communications equipment (transmitters) and the Hydroven 3 as recommended below, according to the maximum output power of the communications equipment.

Rated maximum output power of transmitter W	Separation distance according to frequency of transmitter m		
	150kHz to 80MHz	80MHz to 800MHz	800MHz to 2.5GHz
	$d = 1.2 \sqrt{P}$	$d = 1.2 \sqrt{P}$	$d = 2.3 \sqrt{P}$
0.01	0.12	0.12	0.23
0.1	0.38	0.38	0.73
1	1.2	1.2	2.3
10	3.8	3.8	7.3
100	12	12	23

For transmitters rated at a maximum output power not listed above, the recommended separation distance d in metres (m) can be estimated using the equation applicable to the frequency of the transmitter, where P is the maximum output power rating of the transmitter in watts (W) according to the transmitter manufacturer.

NOTE 1 At 80MHz and 800MHz, the separation distance for the higher frequency range applies.

NOTE 2 These guidelines may not apply in all situations. Electromagnetic propagation is affected by absorption and reflection from structures, objects and people.

3. Introduction

3.1 About this Manual

This manual is your introduction to the Hydroven® 3 system.

You must read and fully understand this manual before using the system.

Use this manual to initially set up the system, and keep it as a reference for day-to-day routines and as a guide to maintenance.

If you have any difficulties in setting-up or using the Hydroven 3 system, contact your local Huntleigh sales representative, listed at the end of this manual.

3.2 Intended Use

The intended use of this product is to manage the list of clinical conditions detailed in the “Indications” section.

The Hydroven 3 system should be used as part of a prescribed plan of care detailed in the “Indications” section.

3.3 About the Hydroven 3 system

The pump supplies air via connecting tubes to an inflatable garment allowing the application of controlled pressure to gently compress the limb. This action assists in increasing the return of blood, excess fluids, improves venous stasis and encourages the reabsorption of waste products.

The pump operates on an automatically timed cycle of 3 minutes, 90 seconds inflation followed by 90 seconds deflation. Variable pressure output ranges from 20-100 mmHg. The garments are inflated alternately.

The Hydroven 3 system operates two types of garments:

- Hydroven 1 garments have a single chamber and provide uniform compression.
- Hydroven 3 garments have three chambers providing graduated segmental compression, inflating distally to proximally.

Optional garment inserts can be used to increase the circumference of the standard arm and leg garments.

A full technical description of the Hydroven 3 system can be found in the Service Manual, part No. SER0014, available from your local Huntleigh sales office.

3.4 Use Environment

Hydroven 3 is suitable for use in hospital, primary care and community settings. It must not be used outdoors, or in any environment where it may come into contact with water.

4. Clinical Applications

4.1 Indications

Intermittent Pneumatic Compression (IPC) is effective in the treatment of the following clinical conditions, when combined with an individualised monitoring programme:

- Oedema.
 - Dependent (including secondary to cerebrovascular incident, pregnancy or paralysis).
 - Traumatic (post-surgical or injury).
- Lymphoedema.
 - Primary and secondary (including post surgery, radio or chemotherapy).
- Chronic venous insufficiency.
- Post phlebotic syndrome.
- Acute and chronic wounds including venous leg ulcers and post-surgical wounds.

IPC may also be beneficial in the management of:

- Fixed flexion deformity.
- Lower limb pain due to trauma or surgery.
- Lipoedema.

Selection should be based upon a holistic assessment of the patients' individual care needs.

Note: These systems represent one aspect of a treatment strategy; if the patient's condition changes the overall therapy regimen should be reviewed by the prescribing clinician.

Note: The above are guidelines only and should not replace clinical judgement

4.2 Contraindications

IPC should NOT be used in the following circumstances:

- Known or suspected deep vein thrombosis (DVT), pulmonary embolism, thrombophlebitis and acute infections of the skin, such as cellulitis.
- Decompensated/severe congestive cardiac failure, pulmonary oedema associated with significant limb oedema or any condition where an increase of fluid to the heart may be detrimental.
- Severe arteriosclerosis or other ischaemic vascular disease.
- Active metastatic disease affecting the limb.



NOTE TO PATIENT: if you are uncertain whether you have any of the above conditions please consult a physician before use.



CAUTION: IPC should be used with care in patients with the following symptoms or conditions:

- **Peripheral neuropathy, pain or numbness in the limb.**
- **Undiagnosed, untreated or infected wounds, fragile skin, grafts or dermatological conditions that may be aggravated by the garment.**
- **Extreme limb deformity which may practically impede the correct application of the garment.**



WARNING: Therapy should be interrupted if pain, tingling or numbness of the limb occurs during or as a result of therapy.



WARNING: In the event of a power failure or fault whereby the garment remains inflated, disconnect the tubeset(s) in order to deflate the garment(s) and then remove the garment(s) from the limb(s).



WARNING: Patients must not walk or stand when wearing leg garments.

5. Preliminary Checks

Contents (supplied with each system)

Item	Item
1 x Hydroven 3	1 x Instructions for Use

Delivery Inspection

Huntleigh Healthcare Ltd takes every precaution to ensure that goods reach you in perfect condition. However, accidental damage can occur in transit and storage. For this reason we recommend that a thorough visual inspection is made immediately the unit is received. Should any damage be evident or any parts missing, ensure that Huntleigh Healthcare Ltd is informed at once.

Storage

If the unit not be required for immediate use, it should be re-sealed into its original packing after carrying out the initial delivery inspection, and stored under covered conditions at a temperature between -20°C to $+50^{\circ}\text{C}$, and relative humidity of 20% to 95% non-condensing.

After exposure to extreme temperatures during storage, the pump must be allowed to adjust to normal operating temperatures for a minimum of 12 hours before use. Failure to do this may result in accelerated wear of mechanical components.

6. Clinical Treatment Guide

An initial pressure setting of 40 mmHg is suggested at the commencement of treatment. It may be necessary to start at a lower level of pressure, dependent on the patient's tolerance.

The pressure can be gradually increased over time, until the required pressure is reached. The upper treatment pressure range is generally 60-70 mmHg.

A single treatment session is usually 20-30 minutes.

Note: The above settings and timings are guidelines, and should not be used as a substitute for clinical judgement and experience.

Note: Loss of mains power will halt therapy.

7. Garment and Insert Information

7.1 Garment Description

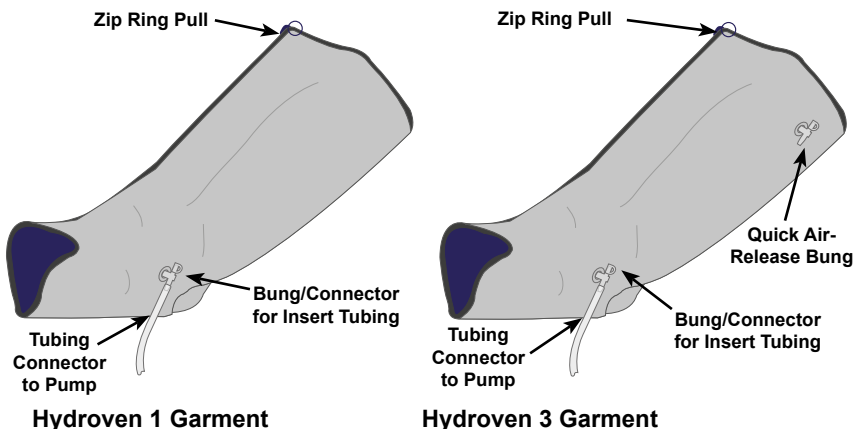

Note: For Hydroven 1 garments, when an insert is not in use, the bung can be used as a quick air release.

7.2 Selecting the correct Garment

- Select the type of garment depending on treatment type:
 - Hydroven 1 garments have a single chamber and provide uniform compression.
 - Hydroven 3 garments have three chambers providing graduated segmental compression, inflating distally to proximally.
- Measure the circumference of the largest part of the limb, and the length in cm/ inch from the heel to the upper thigh for a full leg garment, heel to knee for half leg garment, from shoulder to finger tips for full arm garment, and from elbow to finger tips for half arm garment. Refer to "Accessories" section to order the correct size garment.

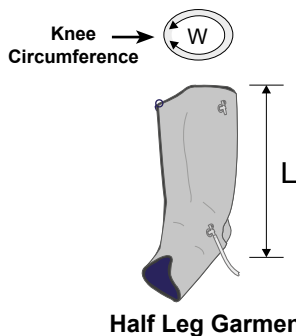

Half Leg Garment

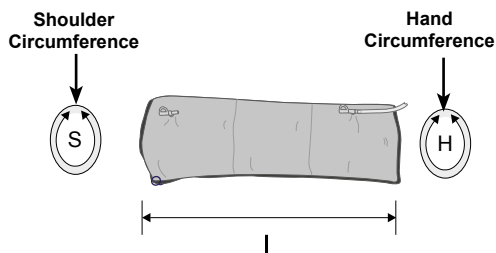

Full Arm Garment

7.3 Applying the Garment



WARNING: Bags supplied with this equipment may present a suffocation risk; to avoid the risk of suffocation, keep the bags away from babies and small children.

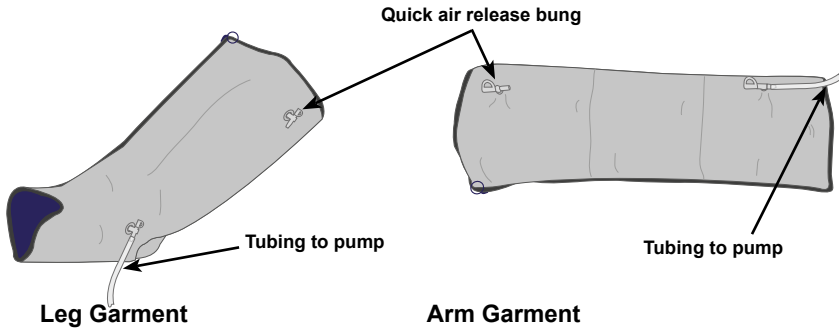

Note: Before fitting the garment ensure all quick air release bungs are closed, as this will effect the efficiency of the garment.

Note: Garments are designed to be worn over thin clothing and not in direct contact with the patients skin.

1. If a larger circumference is required, fit a matching length insert piece before applying to the limb. If appropriate, a primary dressing or stockinette may be used underneath the garments.
2. Undo the zip on the garment.
3. If a garment insert is fitted to the garment, fully fasten one of the zips between the garment and insert, leaving the other unfastened.
4. Before applying the garment (and insert, if fitted) to the limb, zip up the first 150 mm (6") of the unfastened garment zip. Put the garment (and insert) onto the limb and fully fasten the zip. Make sure that the quick air release bung is secured.
5. Make sure the patient is in a comfortable position with the limb supported or elevated as necessary.
6. Check that the insert piece connecting tube is not kinked and is attached to the garment using the lower outlet bung as shown below.
7. Attach the garment tubing to the pump ensuring a "click" is heard from each snap-lock connector.
8. If only one garment is to be used, attach the garment to either port on the pump. The system will automatically identify that only one garment is to be used.

Note: Ensure that the all zips are fully done up on the garment before switching the pump on.

9. Switch on the pump and adjust the pressure control accordingly.

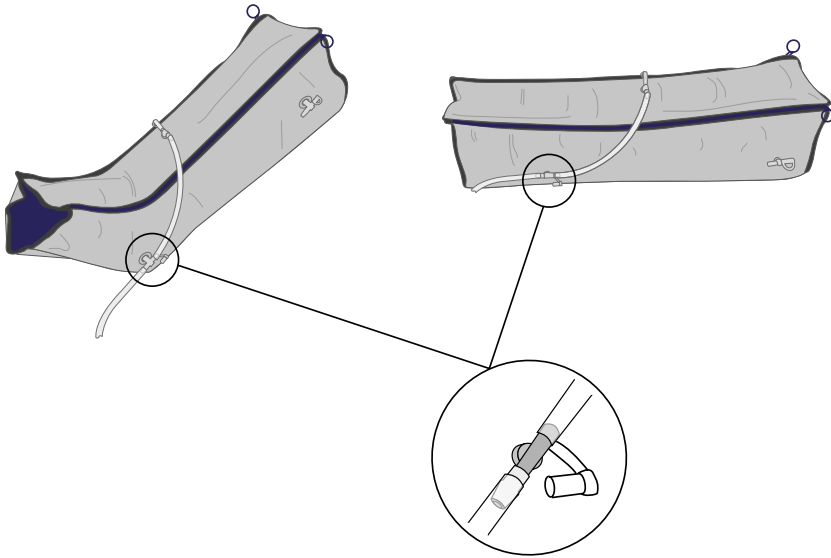

CAUTION: Do not apply the garment to the limb unless it is partially zipped, as you may damage the garment zip.



CAUTION: Do not apply or remove the garment while it is attached to the pump and the pump is in operation, as you may damage the garment zip.



CAUTION: Do not stand or walk while leg garments are fitted.

8. Operation

8.1 Pump Description

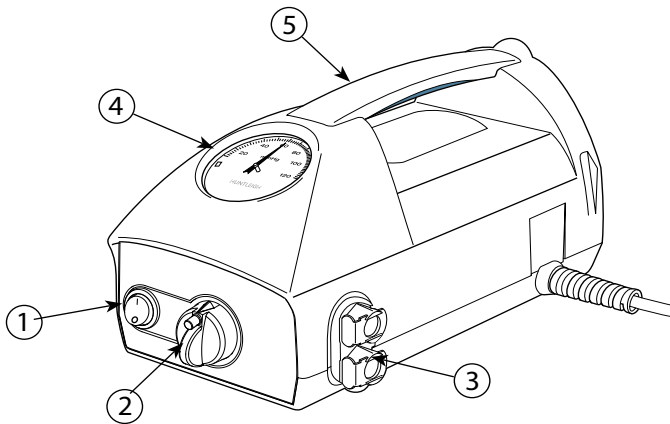

Item No.	Description	Function
1	On/Off Switch	Operation of this switch Starts or Stops the system
2	Pressure Control Knob / Lock Pin* (* If fitted)	Rotate clockwise to increase pressure or counter-clockwise to decrease pressure (pressure range 20 ~ 100 mmHg) The pressure control knob is locked in position, (if Lock Pin is fitted), to prevent accidental movement. Refer to "To Adjust the Pressure Control Knob Position" .
3	Tube Connectors	Snap-lock connectors for Garment attachment
4	Pressure Gauge	Indicates delivery pressure to garment
5	Carry Handle	For easy handling of the pump

Note: If the operation of performance of the pump changes during use, refer to "Trouble Shooting" section of this IFU before calling a service engineer or contacting your local Huntleigh sales office.



CAUTION: Do not apply or remove the garment while it is attached to the pump and the pump is in operation, as you may damage the garment zip.

8.2 Operation



It is the responsibility of the care giver to ensure that the user can use this product safely.

The pump should be placed securely on a flat surface.

Before starting the pump ensure that the garments are properly applied, the zippers are secured and the garment connecting tubes are attached to the pump outlet ports via the snap-lock connectors (3).

8.2.1 To Adjust the Pressure Control Knob Position

The pressure control knob (2) is locked in position* to prevent accidental rotation.

To adjust the position of the pressure control knob:

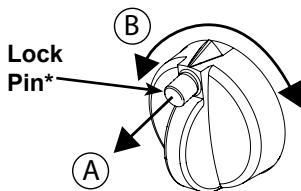

1. Lift the lock pin* (A) to release the control knob.
2. Rotate the control knob (B) whilst the lock pin is raised.
3. Release the lock pin* when the pressure control knob is in the desired position to lock the control knob.

** If lock pin fitted.*

Note: Rotate the pressure control knob clockwise to increase and counterclockwise to decrease pressure

Make sure that the pressure control knob is set to minimum i.e. rotated fully counterclockwise.



WARNING: Ensure that all cables and air hoses are positioned so that they do not present a trip hazard or strangulation.



WARNING: Bags supplied with this equipment may present a suffocation risk; to avoid the risk of suffocation keep the bags away from babies and small children.

8.2.2 Switch On

Connect the pump to the mains power supply using the power cable provided. Turn the mains power switch (1) to the On (I) position.

8.2.3 To Set the Garment Pressure

While the garment is inflating, rotate the pressure control knob (2) slowly clockwise until the required pressure is displayed on the gauge (4).

The garments will take approximately three cycles to fully inflate. Check and adjust as necessary after three inflation cycles.

Note: It might be necessary to start at a lower pressure level dependant on the patient's tolerance. Compression should not cause any discomfort or pain to the patient.

8.2.4 Shut Down

Turn the power switch (1) to the off (O) position. Turning the power off will stop the patient therapy.

Note: If it is required to completely isolate the pump from the mains power, remove the plug from the mains power socket.

8.2.5 To Remove the Garment

Make sure the pump power switch is in the off (O) position, disconnect the tubing from the pump by removing the snap-lock connectors (3), and release the quick air release cap on the garment.

Only open the zip after the garment is completely deflated.

9. Decontamination

The following processes are recommended, but should be adapted to comply with the local or national guidelines (Decontamination of Medical Devices) which may apply within the Healthcare Facility or the country of use. If you are uncertain, you should seek advice from your local Infection Control Specialist.

The Hydroven 3 system should be routinely decontaminated between patients and at regular intervals while in use; as is good practice for all reusable medical devices.



WARNING: Remove the electrical supply to the pump by disconnecting the mains power cord from the mains power supply before cleaning. Protective clothing should always be worn when carrying out decontamination procedures.



CAUTION: Do not use Phenol-based solutions or abrasive compounds or pads during the decontamination process as these will damage the surface coating. Avoid immersing electrical parts in water during the cleaning process. Do not spray cleaning solutions directly onto the pump. Do not immerse the tubeset in water.

9.1 Cleaning

Clean all exposed surfaces and remove any organic debris by wiping with a cloth moistened with a simple (neutral) detergent and water.

Do not allow water or cleaning solutions to collect on the surface of the pump.

9.2 Chemical Disinfection

We recommend a chlorine-releasing agent, such as sodium hypochlorite, at a strength of 1,000ppm available chlorine (this may vary from 250ppm to 10,000ppm depending on local policy and contamination status).





Wipe all cleaned surfaces with the solution, then wipe using a cloth moistened with water and dry thoroughly.



Alcohol based disinfectants (strength 70%) may be used as an alternative.

Ensure the product is dry before storage.

If an alternative disinfectant is selected from the wide variety available we recommend that suitability for use is confirmed with the chemical supplier prior to use.

9.3 Cleaning and Sterilising Garments

Cleaning the Garment			
	Wipe down using a neutral detergent or soap powder at 51°C (120°F).		
	Do not iron		Do not dry clean
			Do not tumble dry
Do not machine wash		Air dry thoroughly.	Do not autoclave

Disinfecting the Garment	
	After cleaning, wipe complete garment over using 70% isopropyl alcohol wipe or a chlorine-releasing agent at 1000 p.p.m. available chlorine.
	Do not use phenol or phenol-derivative disinfectant.
Rinse with clean water to remove any residue.	Air dry thoroughly.

Cleaning the Tubeset			
Use a soft brush.	Air dry only.	Do not immerse in water.	Do not machine wash.

Note: Always refer to local protocols and guidelines, as some protocols recommend single patient use outside of a clinically controlled environment, to avoid cross contamination.

Note: Garments are designed to be worn over thin clothing and not in direct contact with the patients skin.

10. Routine Maintenance

10.1 Hydroven 3 System

10.1.1 Maintenance

The equipment has been designed to be maintenance-free between service periods.

10.1.2 Servicing

Huntleigh will make available on request service manuals, component parts lists and other information necessary for Huntleigh trained personnel to repair the system.

10.1.3 Service Period

Huntleigh recommend that the Hydroven 3 pump is serviced every 12 months by a Huntleigh authorised service agent.

10.2 Hydroven 3 Pump

10.2.1 General Care, Maintenance and Inspection

Check all electrical connections and power cable for signs of excessive wear.

Check the tubeset and connectors for any damage.

In the event of the pump being subjected to abnormal treatment, e.g. immersed in water or dropped, the unit must be returned to an authorised service centre.

10.2.2 Serial Labels

The serial number for the pump is on the label on the back of the pump case. Quote this serial number when requesting service.

11. Trouble Shooting

If you should encounter a problem, please follow the fault finding guide below. If the fault cannot be rectified, please refer to Service.

Fault	Check	Remedy
Pump does not operate.	Is power switch on?	Check switch.
	Is power cord plugged in correctly?	Check connections.
	Fuse blown?	Call service engineer.
Pump operates but garment will not inflate.	Blockage in garment supply tube.	Ensure that the tube airway is clear.
	Garment not fitted correctly to pump.	Check connections.
	Pressure control set too low.	Increase pressure control.
	Air leak in garment.	Check garment. Replace if defective.

Note: If the trouble shooting procedures do not return the system to normal performance, stop using the system immediately and call the service engineer or return the unit to Huntleigh for service. Refer to “Warranty & Service” .

12. Accessories



WARNING: Use only recommended accessories listed in this manual.

Garments

Hydroven 1 Leg Garment			
Order Code	Type	Length (L)	Circumference
5101L50	Half Leg	50 cm	61 cm
5101L66	Full Leg	66 cm	64 cm
5101L71	Full Leg	71 cm	66 cm
5101L76	Full Leg	76 cm	72 cm
5101L84	Full Leg	84 cm	72 cm
5101L92	Full Leg	92 cm	72 cm

Hydroven 1 Arm Garment				
Order Code	Type	Length (L)	Circumference at hand (H)	Circumference at shoulder (S)
5101A51	Half Arm	51 cm	44 cm	56 cm
5101A68	Full Arm	68 cm	44 cm	62 cm
5101A78	Full Arm	78 cm	44 cm	62 cm

Hydroven 3 Leg Garment			
Order Code	Type	Length (L)	Circumference
5103L50	Half Leg	50 cm	61 cm
5103L66	Full Leg	66 cm	64 cm
5103L71	Full Leg	71 cm	66 cm
5103L76	Full Leg	76 cm	72 cm
5103L84	Full Leg	84 cm	72 cm
5103L92	Full Leg	92 cm	72 cm

Hydroven 3 Arm Garment				
Order Code	Type	Length (L)	Circumference at hand (H)	Circumference at shoulder (S)
5103A68	Full Arm	68 cm	44 cm	62 cm
5103A78	Full Arm	78 cm	44 cm	62 cm

Inserts

Hydroven Garment Insert Pieces (to fit Hydroven 1 and 3 Garments)				
Order Code	Type	Length (L)	Circumference Wide End	Circumference Narrow End
510LI50	Half Leg	50 cm	19 cm	14 cm
510LI66	Full Leg	66 cm	19 cm	14 cm
510LI71	Full Leg	71 cm	19 cm	14 cm
510LI76	Full Leg	76 cm	19 cm	14 cm
510LI84	Full Leg	84 cm	19 cm	14 cm
510LI92	Full Leg	92 cm	19 cm	14 cm
510AI68	Full Arm	68 cm	17 cm	12 cm
510AI78	Full Arm	78 cm	17 cm	12 cm

13. Specifications

13.1 Equipment Classification

Type of protection against electric shock.	Class II, Double Insulated
Degree of protection against electric shock 	Type BF
Mode of operation.	Continuous
Degree of protection against solid and liquid ingress	IP21* - Protection against ingress of solid objects more than 12.5mm diameter and water droplets falling vertically. IPX0* - No Protection
Degree of safety of application in the presence of a flammable anaesthetic	Equipment not suitable for use in the presence of a FLAMMABLE ANAESTHETIC MIXTURE WITH AIR, OXYGEN OR NITROUS OXIDE

13.2 General

Model	Hydroven 3
Part Numbers	510001 UK 510009AU Australia & New Zealand 510009ZA South Africa & India
Pressure Range	20 - 100 mmHg \pm 5%
Supply voltage	230 V AC
Supply Frequency	50Hz
Pump Fuse Rating	F500 mA 250 V
Plug Fuse Rating	5A to BS1362 (UK ONLY)
Power input	14 VA
Case Material	Fire Retardant ABS Plastic
Size	270 x 130 x 150 mm (10.6 x 5.1 x 5.9")
Weight	2.5 kg (5.5 lb)

* See product label for IP Rating

13.3 Environmental

Condition	Temperature range	Relative Humidity	Atmospheric Pressure
Operating	5°C to 40°C (41°F to 104°F)	30% to 75% (non condensing)	700 to 1060 hPa
Storage and transport (Long term)	10°C to 40°C (50°F to 104°F)	20% to 95% (non condensing)	700 to 1060 hPa
Storage and transport (short term)	-25°C to 70°C (-13°F to 158°F)	20% to 95%	500 to 1060 hPa















Note: When exposed to extreme temperature during storage, the pump must be allowed to adjust to normal temperatures for a minimum of 12 hours before use. Failure to do so may result in accelerated wear of mechanical components.

13.4 Standards Compliance







EN60601-1:1990/A13:1996 and IEC 60601-1:1988/A2:1995
EN60601-1-1:2001 and EN60601-1-2: 2001
UL60601-1, UL2601-1 and CAN/CSA C22.2 No. 601.1-M90
EN60601-1:2006, EN60601-1-11:2010* and IEC 60601-1:2005
AAMI/ANSI ES60601-1:2006 and CAN/CSA C22.2 No.60601.1(2008)
EN62366:2008
BS EN 980:2008

* Only applies to IP21 rated products (see product label for IP rating)

14. Product Labelling

Symbols			
	Hydroven 3 is Class II, double insulated according to the definitions in BS EN 60601-1:1990		
	Applied parts are type BF according to the definitions in BS EN 60601-1:1990		
	Refer to this document (Instructions for Use) for a description of the product classification (3rd Edition).		
	Alternating Current (AC)		
	With respect to electric shock, fire and mechanical hazards only in accordance with CAN/CSA-C22.2 No. 60601.1 (2008). MEDICAL EQUIPMENT		
	This symbol signifies that this product, including its accessories and consumables is subject to the WEEE (Waste Electrical and Electronic Equipment) regulations and should be disposed of responsibly in accordance with local procedures.		
	Refer to this document (Instructions for Use) for a description of the product classification (2nd Edition).		
	This symbol signifies that this product complies with the essential requirements of the Medical Device Directive (93/42/EEC) - Medical Device Regulation (EU/2017/745)		
Manufactured For:	Huntleigh Healthcare Ltd. 35 Portmanmoor Road, Cardiff, CF24 5HN, United Kingdom T: +44 (0)29 20485885 sales@huntleigh-diagnostics.co.uk www.huntleigh-diagnostics.com		
	Legal Manufacturer in association with the CE mark in Europe ArjoHuntleigh AB Hans Michelsensgatan 10 211 20 Malmö, Sweden		
	Power: Disconnects from the mains supply		Power: Connects to the mains supply
	Follow Instructions for Use		Fuse
	Serial Number		Reference Number

	Medical Device		Cardboard packaging can be recycled.
---	----------------	---	--------------------------------------

Cleaning Symbols			
	Wipe surface with damp cloth		Use solution diluted to 1000 ppm of Available Chlorine
	Do not iron		Do Not Use Phenol-based cleaning Solutions
	Do not dry clean		Do not tumble dry

15. End of Life Disposal

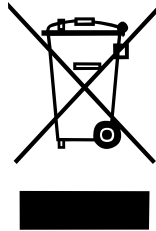

This symbol signifies that this product, including its accessories and consumables is subject to the WEEE (Waste Electrical and Electronic Equipment) regulations and should be disposed of responsibly in accordance with local procedures.

16. Warranty & Service

Huntleigh Healthcare Diagnostic Products Division standard terms and conditions apply to all sales. A copy is available on request. These contain full details of warranty terms and do not limit the statutory rights of the consumer.

16.1 Service Returns

If for any reason the Hydroven 3 has to be returned, please:

- Clean the product following the instructions in this manual.
- Pack it in suitable packing.
- Attach a decontamination certificate (or other statement declaring that the product has been cleaned) to the outside of the package.
- Mark the package 'Service Department '

For further details, refer to NHS document HSG(93)26.

Huntleigh Healthcare Ltd reserve the right to return product that does not contain a decontamination certificate.

Service Department.
Huntleigh Healthcare, Diagnostic Products Division,
35, Portmanmoor Rd.,
Cardiff. CF24 5HN
United Kingdom.

Tel: +44 (0)29 20485885
Fax: +44 (0)29 20492520
Email: sales@huntleigh-diagnostics.co.uk
service@huntleigh-diagnostics.co.uk
www.huntleigh-diagnostics.com

This section is only applicable to United Kingdom (UK) market when UK marking is applied to the Arjo medical device labelling.

UK Symbol:

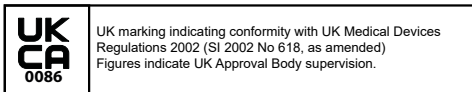

UK Responsible Person & UK Importer:

Arjo (UK) Ltd., ArjoHuntleigh House, Houghton Regis. LU5 5XF

Is the appointed UK Responsible Person as defined in UK Medical Devices Regulations 2002 (SI 2002 No 618, as amended).

For Northern Ireland (NI) CE marking will still apply until further amendment to applicable regulations.

If a serious incident occurs in relation to this medical device, affecting the user, or the patient then the user or patient should report the serious incident to the medical device manufacturer or the distributor.
In the European Union, the user should also report the serious incident to the Competent Authority in the member state where they are located.

Manufactured for Huntleigh Healthcare Ltd on behalf of;



ArjoHuntleigh AB
Hans Michelsensgatan 10
211 20 Malmö, Sweden



www.huntleigh-diagnostics.com/

Huntleigh Healthcare Ltd.

35 Portmanmoor Road, Cardiff, CF24 5HN, United Kingdom
T: +44 (0)29 20485885 sales@huntleigh-diagnostics.co.uk
www.huntleigh-diagnostics.com



www.huntleigh-healthcare.us/

Registered No: 942245 England & Wales. Registered Office:
ArjoHuntleigh House, Houghton Hall Business Park, Houghton Regis, Bedfordshire, LU5 5XF
©Huntleigh Healthcare Limited 2015

A Member of the Arjo Family

As our policy is one of continuous improvement, we reserve the right to modify designs without prior notice.

HUNTLEIGH